



SOSEN LED Driver, Your Smart Choice

Specifications

SS-800VP-E Integrated Series LED Driver

Model: SS-800VP-EXXBH*

Description:
800W LED Integrated Driver

Rev.: V01

Release Date: 2025-01-10

SS-800VP-E Integrated Series LED Driver

SOSEN
LED DRIVER



LED DRIVER

VP-E Series



Features:

- Efficiency up to 95.5%
- Dimming: 0-10V,PWM,Resistor,Timing
- Dim-to-Off
- Surge Protection: CM: 10kV, DM: 6kV
- AUX Power: 12V/0.2A
- Constant Lumen, Life Warning
- Standby Power<0.5W
- Communication Function With PC
- Type HL, suitable for hazardous locations
- Protections: SCP/OTP/OVP
- Warranty: 5 years



Description:

SS-800VP-E Integrated series are 800W constant current LED Driver with wide O/P voltage range and adjustable O/P current by program.LED luminaries manufactures can easily design luminaries and reduce cost.

Application:

Horticulture lighting

Model List:

Model	AC Input Range	Max. Pout	Vout Range	Full Power Vout Range	Iout	Default Current	THD (Typ.)	PF(Typ.)	Eff.(Typ.)	Max.Tc
SS-800VP-E56BH*	90-305Vac	800W	28-56V	48-56V	1.75-16.7A	14.3A	10%	0.95	95%	90°C

Note:

- 1.Default Tested: at 220Vac, full load, Ta 25°C.
- 2.The performance of the LED Driver can be guaranteed within the full power Vo range.The voltage lower than full power Vo range, it is need to test the performance with the LED module;

SS-800VP-E Integrated Series LED Driver

“*” Means Additional Function

“*”	AC INPUT		DC OUTPUT				Dimming		Remark
	Cable	M19-3Pin	Cable	M19-2Pin	M19-3Pin	M19-4Pin	Knob&RJ25	M12-3Pin	
B	✓		✓				✓		
B-M2		✓		✓			✓		
B-M3		✓			✓		✓		
-M2		✓		✓				✓	
-M3		✓			✓			✓	

Input Characteristics:

Parameter	Min.	Typ.	Max.	Remark
Rated AC Input Range	120Vac		277Vac	
AC Input Range	90Vac		305Vac	
Input Frequency Range	47Hz	50/60Hz	63Hz	
Max Input Current			9A	120Vac, full load
Max Input Power			910W	120Vac, full load
Max Inrush Current(120Vac)			30A	Cold Start
Max Inrush Current(220Vac)			56A	Cold Start
Max Inrush Current(277Vac)			70A	Cold Start
Standby Power			0.5W	220Vac/50Hz, Dim to off
Power Factor	0.95	0.97		220Vac/50Hz, full load
	0.90			120-277Vac, 70-100% load
THD		8%	10%	220Vac/50Hz, full load
			20%	120-277Vac, 70-100% load

SS-800VP-E Integrated Series LED Driver

O/P Characteristics:

Parameter	Min.	Typ.	Max.	Remark
O/P Voltage Range	28V		56V	Power Derated @28-48V
Rated O/P Voltage	48V		56V	Po=Vo*Io=800W, full load
Rated O/P Current	14.3A		16.7A	16.7A for 48V,14.3A for 56V
Adj. O/P Current (AOC)Range	1.75A		16.7A	By Programming
No Load Voltage			60V	
Efficiency @120Vac	90.0%	92.0%		O/P 56V/14.3A
Efficiency @220Vac	93.0%	95.0%		O/P 56V/14.3A
Efficiency @277Vac	93.5%	95.5%		O/P 56V/14.3A
O/P Current Tolerance	-5%		+5%	
O/P Current Ripple(PK-AV)		5%	10%	Full load
Start-up Current Overshoot			10%	Full load
Start-up Time			0.5S	120Vac,Full load
			0.5S	220Vac,Full load
Line Regulation	-2%		+2%	Full load
Load Regulation	-2%		+2%	
Temperature Coefficient		0.03%/°C		Tc:0°C~90°C
OTP	90°C	100°C	110°C	Drop current when OTP, and it can be automatically restored after the abnormality is removed.
Short Circuit Protection				Driver not be damaged

SS-800VP-E Integrated Series LED Driver

Other Characteristics:

Parameter	Min.	Typ.	Max.	Remark	
AUX Power	O/P Voltage	11.4V	12V	13.8V	
	O/P Current	0mA	200mA		
0-10V Dimming (Optional)	Dim Vcc	0V		12V	Negative dimming by programming
	Dim Range	10%loset		100%loset	DIM+ source current 110uA .
	Rec.Dim Range	0V		10V	Dimming prohibits reverse connection.
PWM Dimming (Optional)	PWM High	9.8V		10.2V	Negative dimming by programming
	PWM Low	0V		0.3V	DIM+ source current 110uA .
	Frequency	1KHz		2KHz	Dimming prohibits reverse connection.
	PWM Duty	0%		100%	
Resistor Dimming (Optional)	Resistance	0K		100K	Negative dimming by programming
	Dim Range	10%		100%	DIM+ source current 110uA .
Dim to Off	Dim off	7%	8%	9%	
	Dim on	8%	9%	10%	
Timing Curve(Optional)	By programming				
Constant Lumen(Optional)	By programming				
Life Warning(Optional)	By programming				
Life Time($T_c \leq 75^\circ\text{C}$)	50,000 hours			80% Load	
MTBF	202,300 hours			220Vac,full load, $T_a=25^\circ\text{C}$ (MIL-HDBK-217F)	
T_c	90°C				
Warranty	5 years			$T_c: 75^\circ\text{C}$	
Net Weight	2950g				
Dimension	390mm*89.5mm*44.5mm			L x W x H	

NOTE:

- 1.All the parameters above are tested $T_a 25^\circ\text{C}$ and LED load, unless specified.
2. When using resistor dimming (parallel connection of dimming wires), if the number of parallels is: N, the dimming resistor should be realized 0-100% dimming range, resistance value: $91\text{K}\Omega/\text{N}$.

SS-800VP-E Integrated Series LED Driver

Environmental Requirements

Parameter	Min.	Typ.	Max.	Remark
Operating Temperature(Tcase)	-40°C	25°C	+90°C	
Storage Temperature	-40°C	25°C	+90°C	
Operation Humidity	10%RH		90%RH	
Storage Humidity	5%RH		95%RH	
Altitude	-65m		4000m	

Safety and EMI/EMS Standards

Certification	Standard	Status	Remark
UL/cUL	UL8750	✓	
ENEC	EN 61347-1:2015 EN 61347-2-13:2014 EN 61347-2-13:2014/A1:2017	✓	
UKCA	EN 61347-1:2015+A1:2021 EN 61347-2-13:2014+A1:2017 EN 62493:2015 BS EN 61347-1:2015+A1:2021 BS EN 61347-2-13:2014+A1:2017 BS EN 62493:2015	✓	
CE	EN 61347-2-13:2014 EN61347-1:2008+A1:2011+A2:2013	✓	

EMI/EMS	Criterion	Remark
Conduction Emission	EN55015:2013+A1:2015	230Vac
	FCC Part 15 Subpart B; ANSI C63.4:2014	120Vac: Class A;
Radiation Emission	EN55015:2013+A1:2015	230Vac
	FCC Part 15 Subpart B; ANSI C63.4:2014	120Vac: Class A;
Harmonic Current Emissions	IEC/EN 61000-3-2	Class C
Surge	IEC/EN 61000-4-5	DM: 6kV,CM: 10kV,Criterion B
	ANSI/C82.77-5-2017	DM: 6kV,CM: 6kV,Criterion B
Ring Wave	IEC/EN 61000-4-12	DM: 6kV,CM: 6kV,Criterion B

SS-800VP-E Integrated Series LED Driver

Safety Test Items:

Safety Test Items	Technical Indicators		Remark
Insulation Requirements	UL Insulation Requirements	ENEC Insulation Requirements	
Input-O/P	2U+1000Vac	4U+2000Vac	
Input-Case	2U+1000Vac	2U+1000Vac	
Input-Dim	2U+1000Vac	4U+2000Vac	
Insulation Resistance	$\geq 10M\Omega$		Input-O/P, Test voltage: 500Vdc
Ground Resistance	$\leq 0.1\Omega$		25A/1min
Leakage Current	$\leq 0.75mA$		277Vac

NOTE:

1. SOSEN warrants the LED Driver itself complies with EMC standard. However, LED Driver's EMC should be re-checked when integrated into lighting systems due to unexpected interference as component.
2. Please short (ACL and ACN), (V+ and V-), (Dim+ and Dim - and Vaux+ and Vaux-) when Hi-pot test.

Performance Curves:

Input Inrush Current

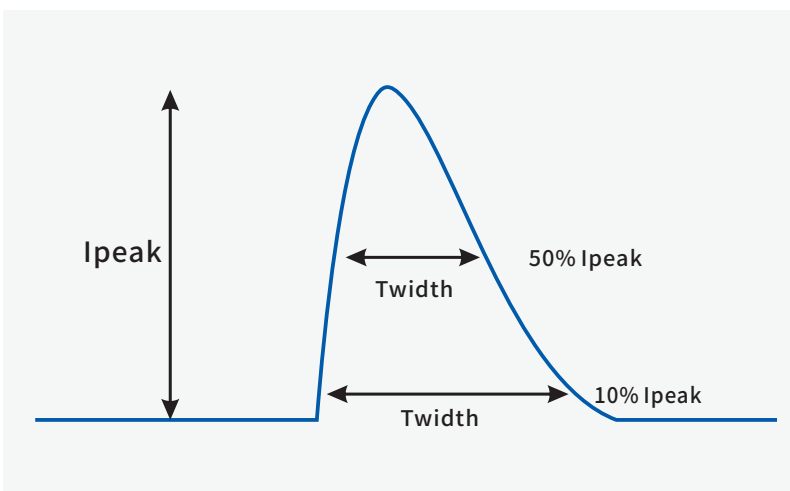

Vin	Ipeak	T(@10% of Ipeak)	T(@50% of Ipeak)
120Vac	30A	11mS	4mS
220Vac	56A	11mS	4mS
277Vac	70A	12mS	4mS

SS-800VP-E Integrated Series LED Driver

Performance Curves:

O/P Voltage Vs. O/P Current(DIM/AOC Window)

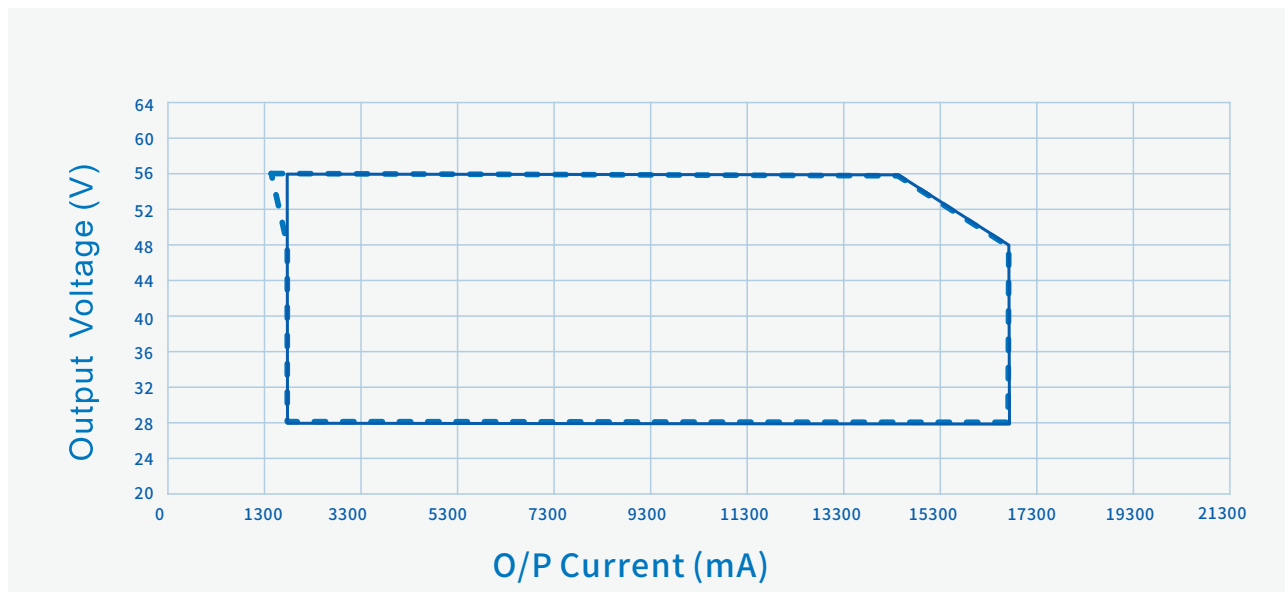

----- Dimming Window

———— AOC Window

Efficiency Vs. O/P Voltage (Vin=120Vac)

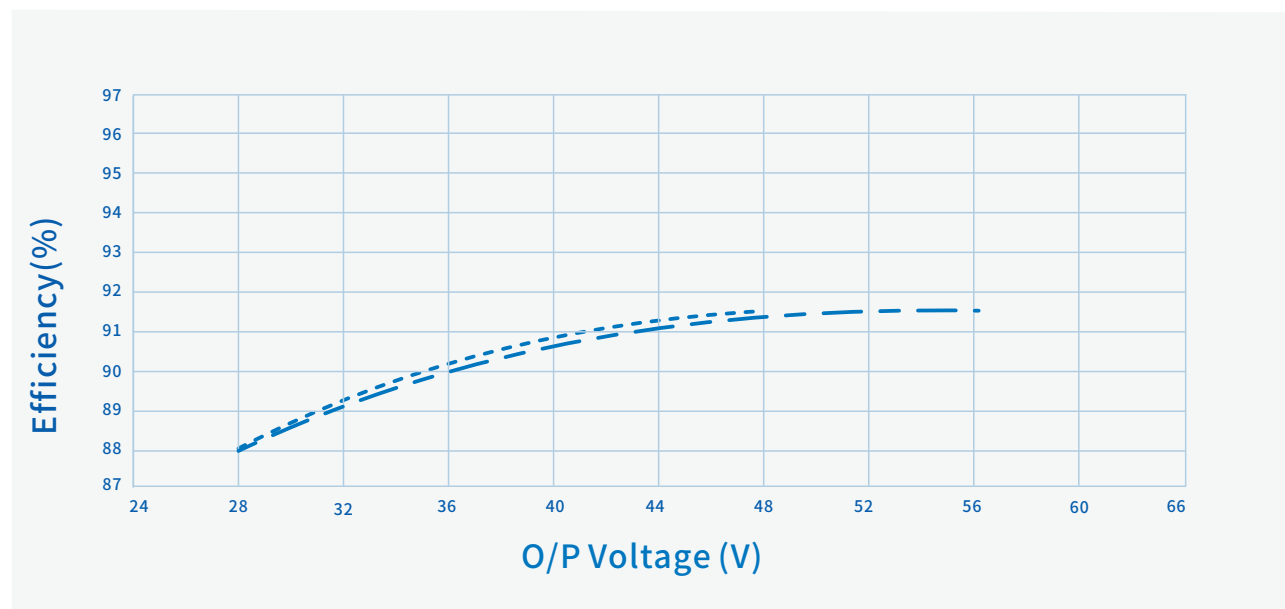

----- Io=16700mA

- - - - Io=14300mA

SS-800VP-E Integrated Series LED Driver

Performance Curves:

Efficiency Vs. O/P Voltage ($V_{in}=220V_{ac}$)

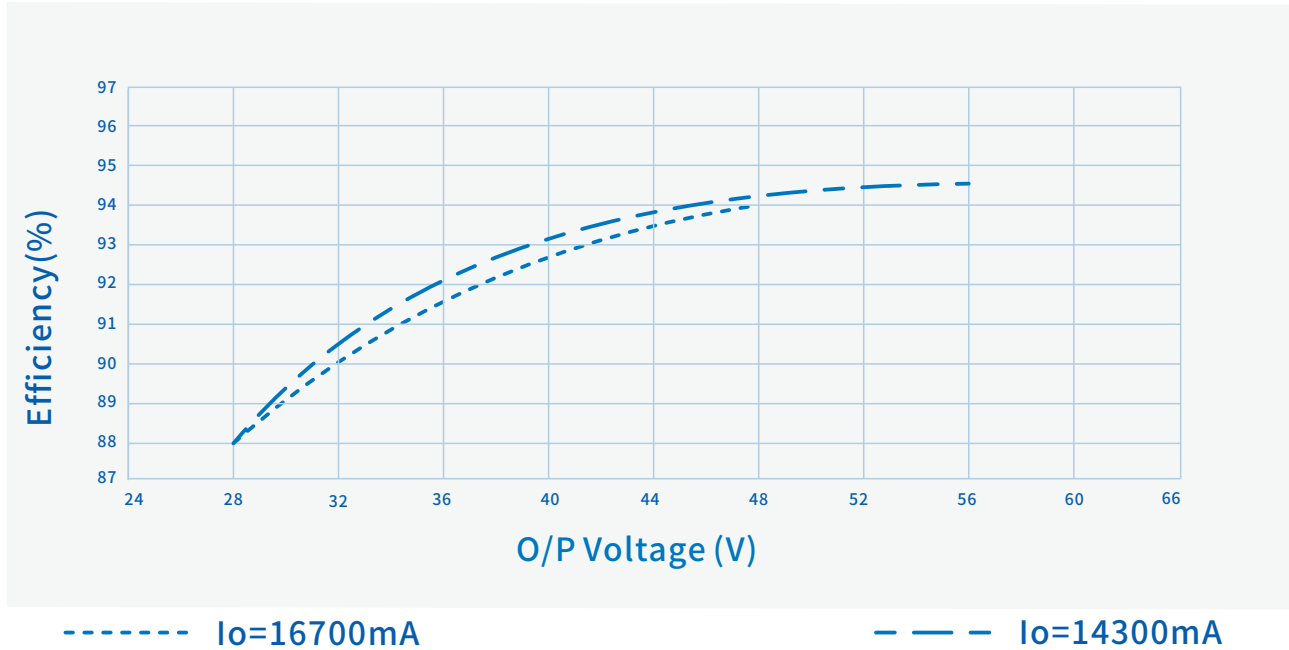

Efficiency Vs. O/P Voltage ($V_{in}=277V_{ac}$)

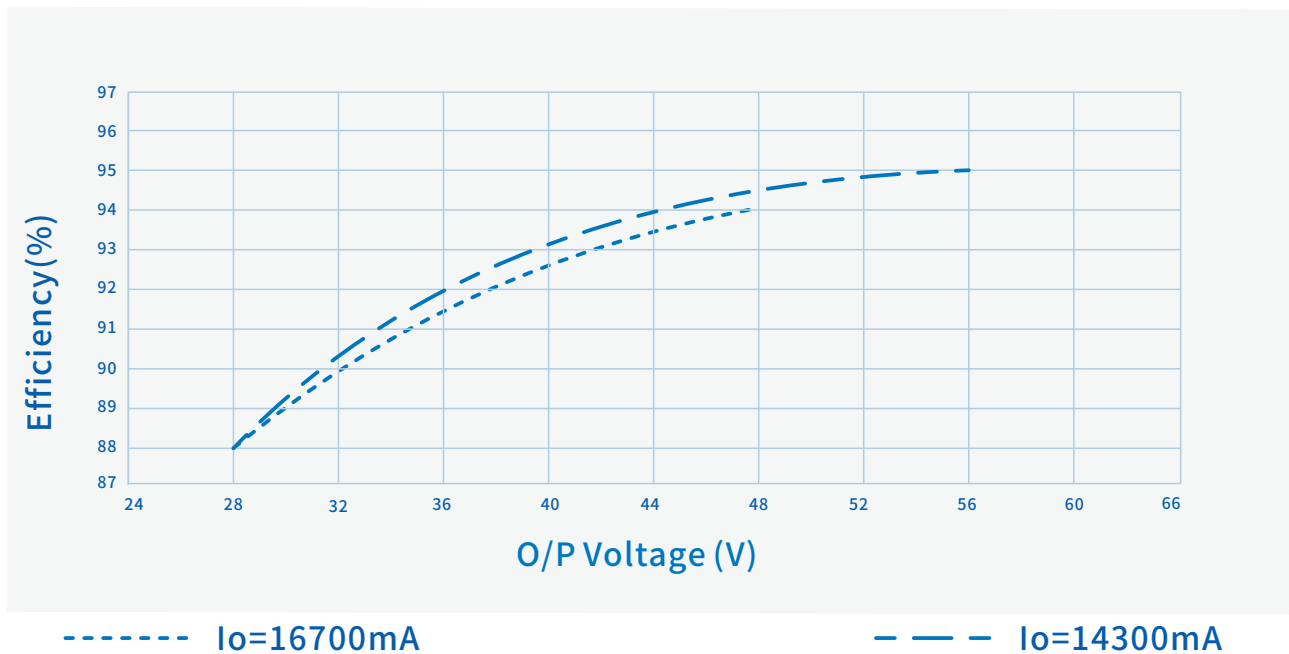

SS-800VP-E Integrated Series LED Driver

Performance Curves:

Power Factor Vs. O/P Power

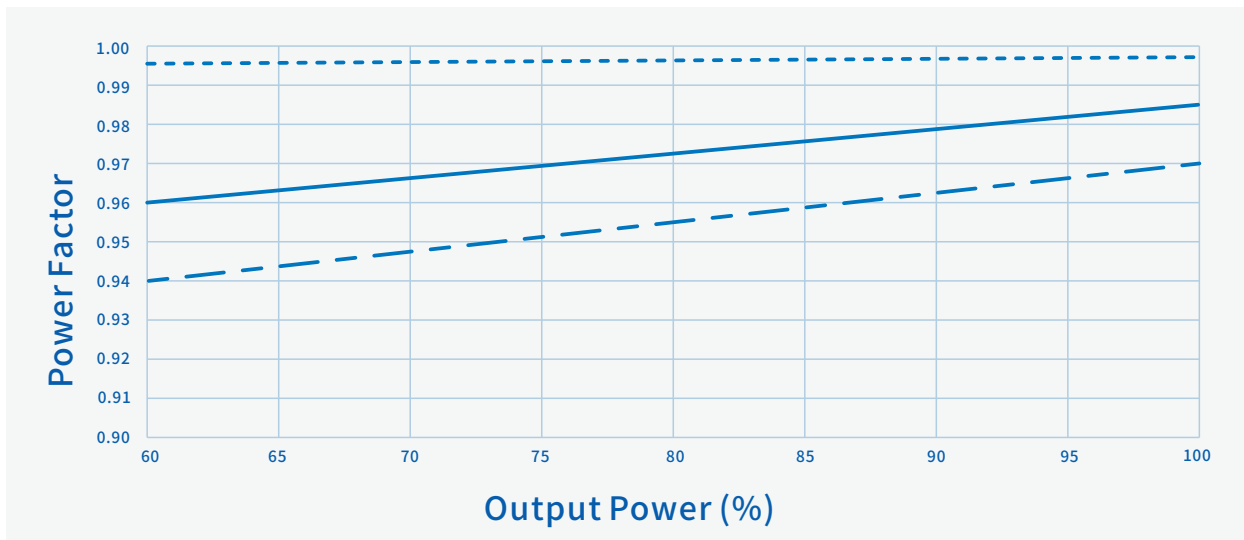

----- Vin=120Vac ————— Vin=220Vac - - - - Vin=277Vac

THD Vs. O/P Power

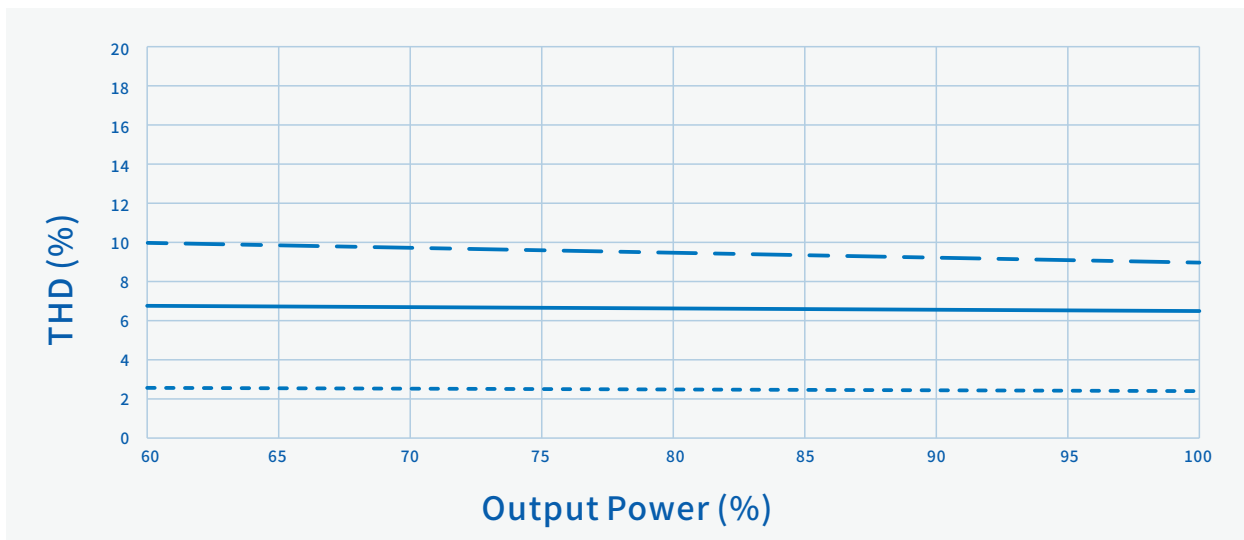

----- Vin=120Vac ————— Vin=220Vac - - - - Vin=277Vac

SS-800VP-E Integrated Series LED Driver

Performance Curves:

O/P Power Vs. Input Voltage (Automatic derate)

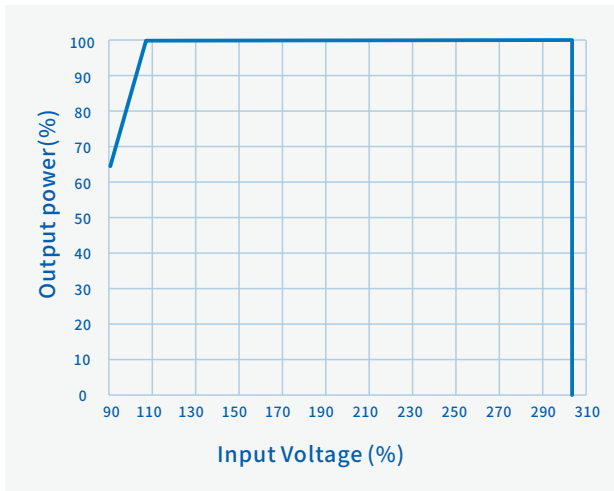

O/P Power Vs. Case Temperature

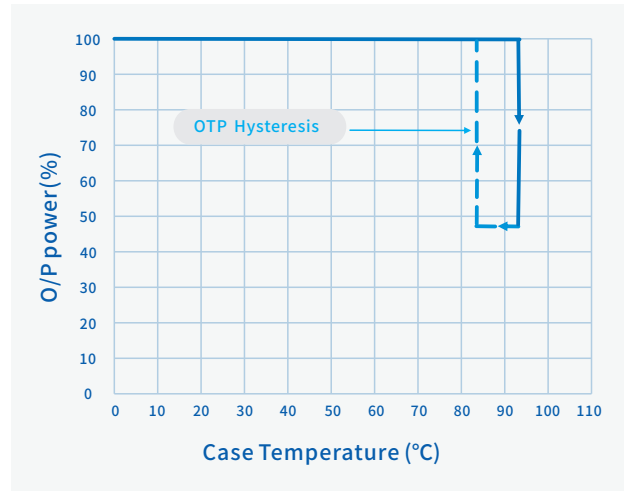

O/P Power Vs. Dimming

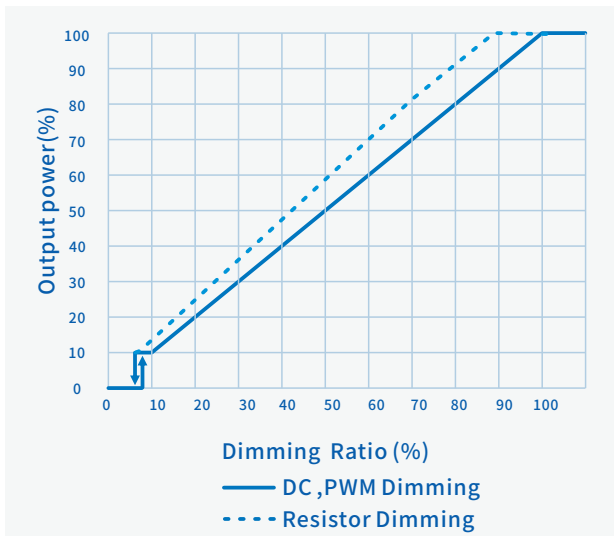

Life Time Vs. Case Temperature

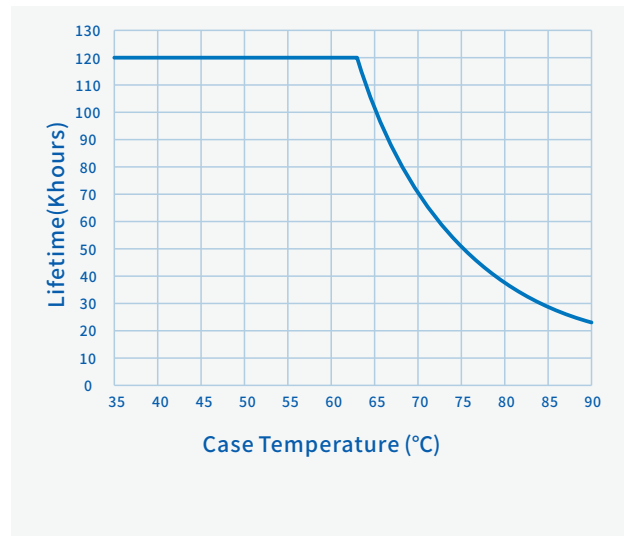

SS-800VP-E Integrated Series LED Driver

Programming Connection Diagram:

Legacy Timer: Driver's O/P follows the pre-programmed timing curve after turn-on.

Auto-Adjust by Percentage: Driver's O/P will be adjusted by automatically changed dimming curve by the period percentage based on the latest 5 dimming curve.

Auto-Adjust by Mid-point: Driver's O/P will be adjusted by automatically changed dimming curve by mid-point based on the latest 5 dimming curve.

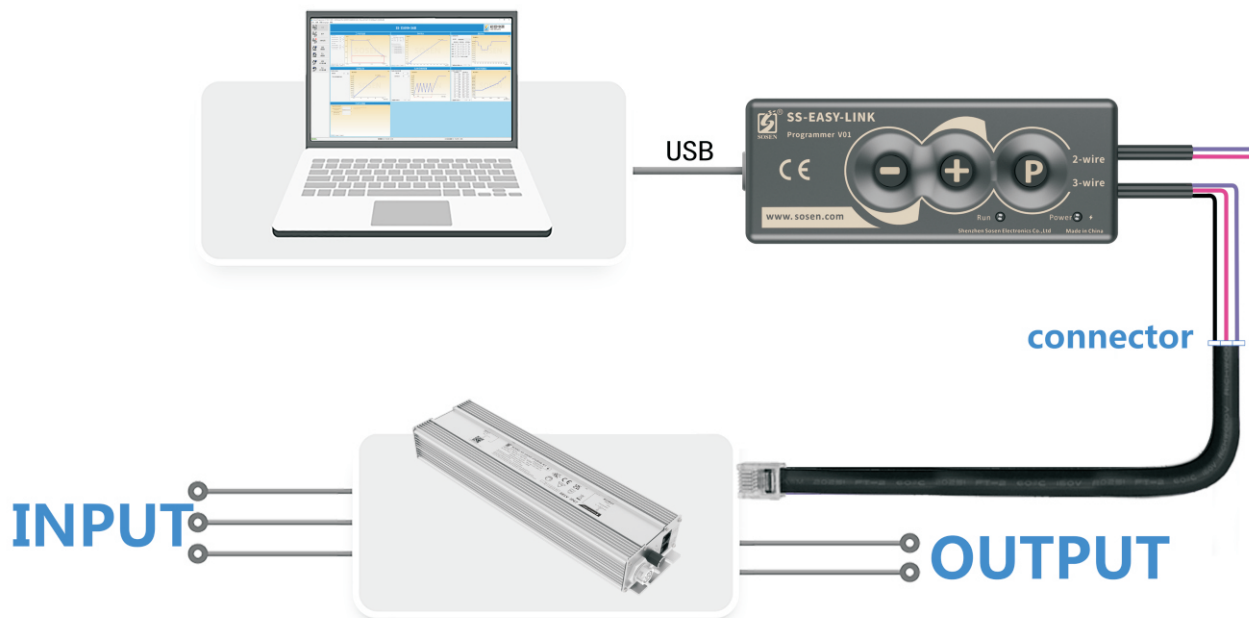

Note:

Programming could be completed by off-line mode either without turn on the Driver nor without PC, other than the traditional on-line mode.

SS-800VP-E Integrated Series LED Driver

Parameter		Remark
Dimming Settings	Dimming voltage default 10V (source current)	Factory Default Mode(other models)
	Dimming voltage default 0V (sink current)	Factory Default Mode(BHB* models)

Note:

According to the application of the dimmer, customers can set the two modes of “dimming voltage default 10V (output current)” / “dimming voltage default 0V (draw current)” by Songsheng programming software.

Settings Interface

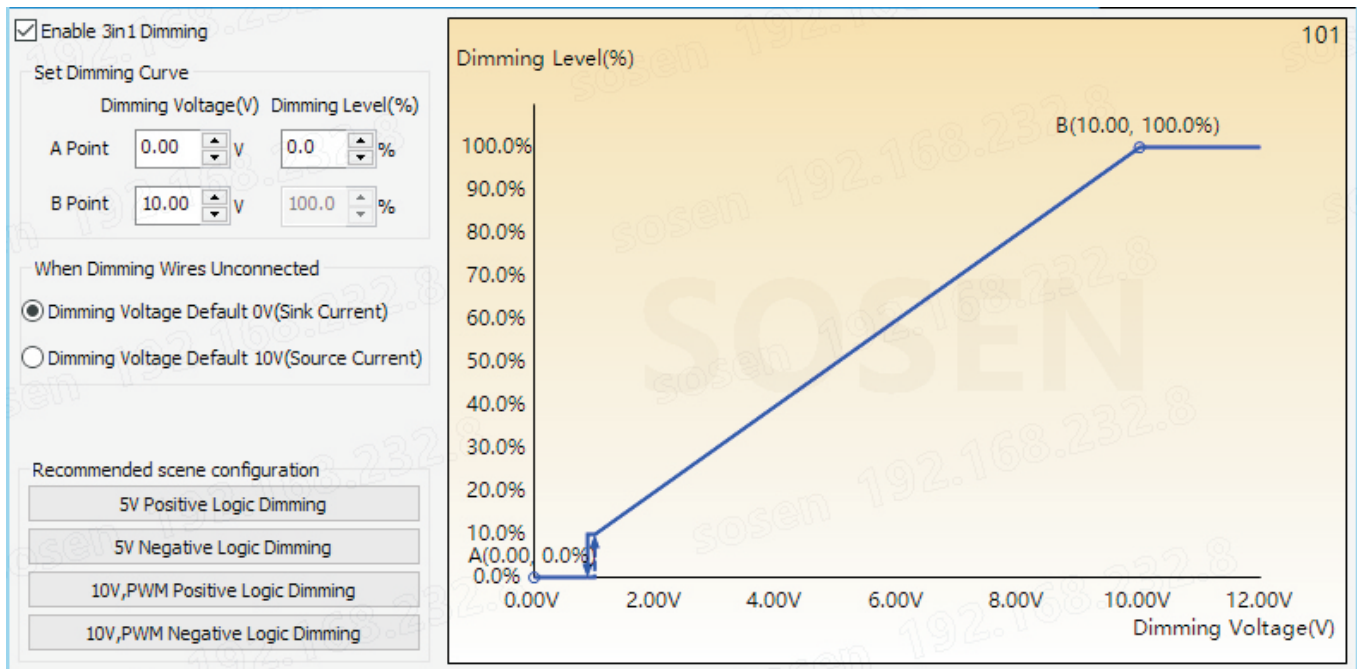

SS-800VP-E Integrated Series LED Driver

Mechanical Characteristics (BHB models)

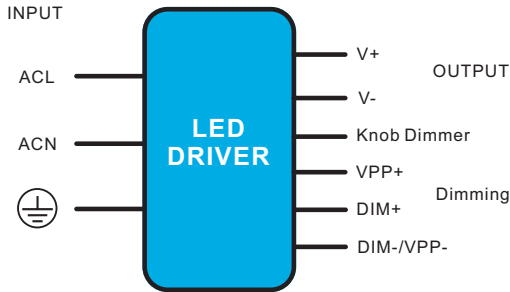

AC Input Cable(Exposed Length $450 \pm 10\text{mm}$):

Global model: SJOW, 3*17AWG, O.D: 8.0mm, Brown: L, Blue: N, Yellow/Green: \oplus
 UL model: SJTW, 3*18AWG, O.D: 7.8mm, Black:L, White:N, Green: \oplus

DC O/P Cable(Exposed Length $250 \pm 10\text{mm}$):

Global model: SJOW, 2*12AWG, O.D: 10.7mm, Black: V+, White: V-
 UL model: SJTW, 2*12AWG, O.D: 9.2mm, Black: V+, White: V-

DIM/AUX Power/Programming Cable:

Knob Dimmer, RJ25 port

Name Description	Standard Code	mm(In.)
Overall Length	L1	390(15.34)
Mounting Hole Length	L2	377(14.83)
Case Length	L3	364(14.31)
Case Width	W1	89.5(3.52)
Mounting Hole Width	W2	40(1.57)
Case Height	H	44.5(1.75)
TC Point Position	X	269(10.59)
TC Point Position	Y	45(1.77)

Note:

- 1, Please follow the "LED Driver User Manual" obtained from SOSEN's official website for assembly.
- 2, AC Input Cable, DC O/P Cable, Peeled length of cable: $43 \pm 5\text{mm}$, Tinned length of wire: $10 \pm 2\text{mm}$.

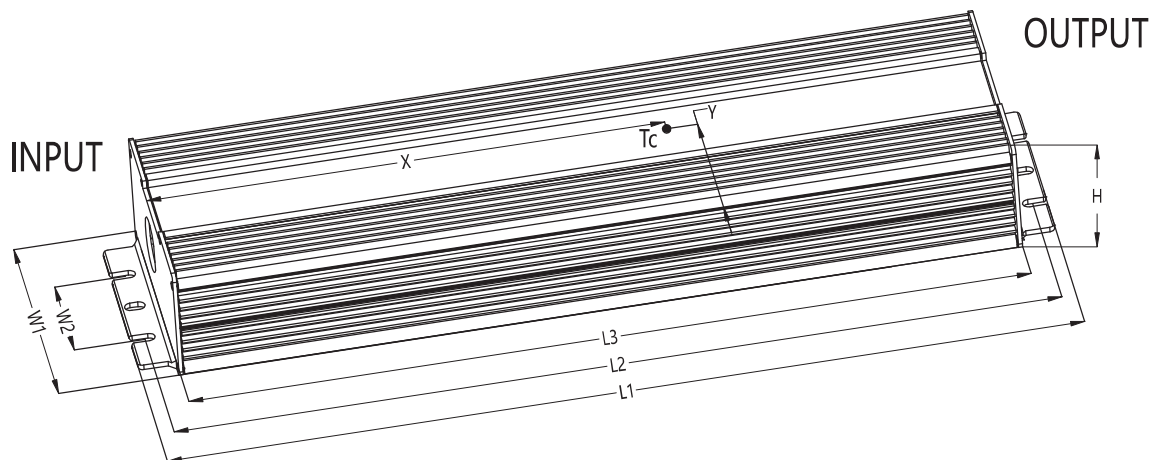

SS-800VP-E Integrated Series LED Driver

Mechanical Characteristics (BHB-*models)

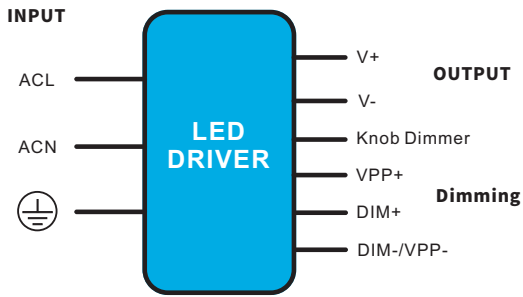

INPUT	OUTPUT	
M19LLT-3Pin	M19LLT-2Pin	M19LLT-3Pin
M19JNICON-3Pin	M19JNICON-2Pin	M19JNICON-3Pin
Dimming : Knob&RJ25		

Name Description	Standard Code	mm(In.)
Overall Length	L1	390(15.34)
Mounting Hole Length	L2	377(14.83)
Case Length	L3	364(14.31)
Case Width	W1	89.5(3.52)
Mounting Hole Width	W2	40(1.57)
Mounting Hole Width	W3	21(0.83)
Case Height	H	44.5(1.75)
TC Point Position	X	269(10.59)
TC Point Position	Y	45(1.77)

Note:

1, Please follow the "LED Driver User Manual" obtained from SOSEN's official website for assembly.

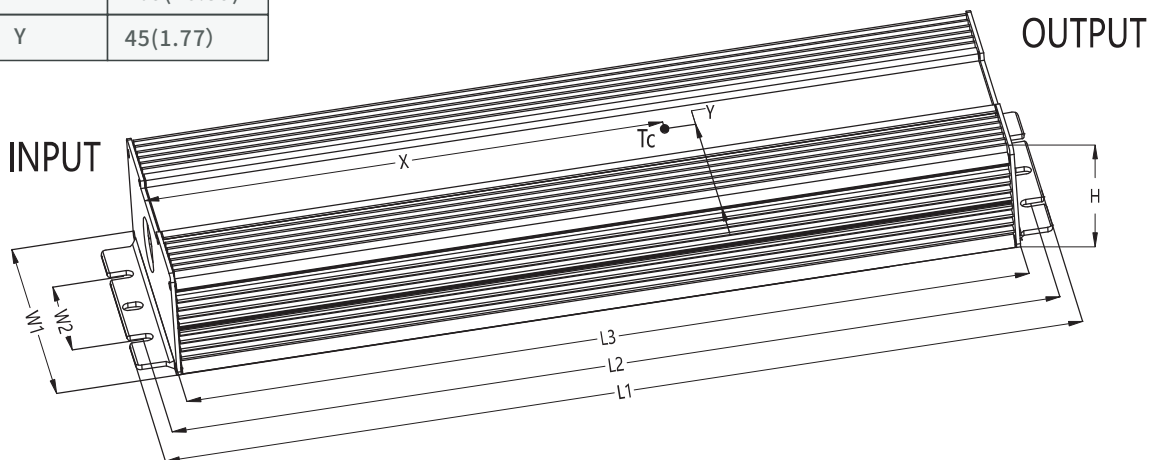

SS-800VP-E Integrated Series LED Driver

Knob/RJ25 terminal definition:



PLUG

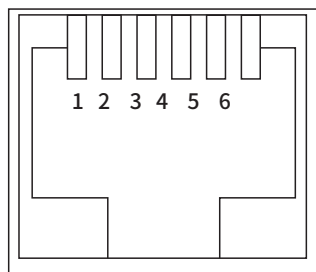

JACK

RJ25 PIN	
1&6	VPP+
2&5	DIM+
3&4	DIM-/VPP-

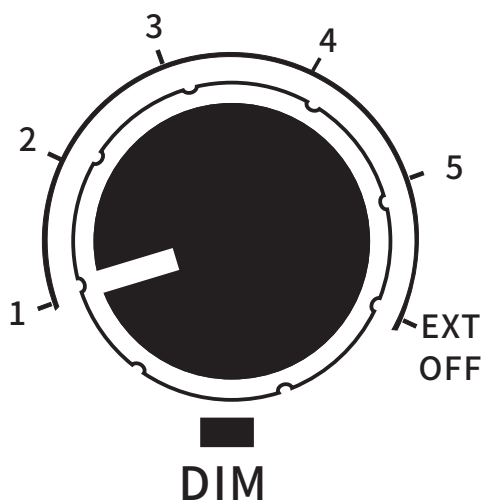

	Definition
1	40%loset
2	50%loset
3	60%loset
4	80%loset
5	100%loset
EXT/OFF	External Dimming /Dim to off

SS-800VP-E Integrated Series LED Driver



Assembly Tips

1. When the dimmer port is not in use, please insulate and seal the dimmer port, so as not to string into the interfering signal to cause damage to the dimmer line and affect the normal operation of the power supply.

Package

- Outside carton dimension: L×W×H=577mm×385mm×162mm;
- 5PCS/Carton;
- Net weight/Piece: 2.95kg;Gross weight/Carton: 16.2kg;
- Please refer to the product name, model number, manufacturer identification, QC PASS, manufacturing date on the package.

Transportation

Packaging is designed suitable for transportation by trucks, vessels and flights. The products should be avoided direct sunlight and rain, loaded/unloaded with caution.

Storage

The product storage meets the standard of the GB 3873—83.
Products should be rechecked if stored for over 1 year before assembly.

RoHS

Products comply with RoHS Directive (2011/65/EU) and amendment 2015/863/EU.

Revision History

Version	Description of Update	Updated Date	Remark
V00	Original Release	2024/12/19	
V01	Updated structural dimensional characteristics	2025/01/10	